

THIS DRAWING IS FOR ILLUSTRATION PURPOSES ONLY AND IS NOT TO BE RELIED UPON FOR ANY OTHER PURPOSE. NO WARRANTY OF MERCHANTABILITY, OF FITNESS FOR A PARTICULAR PURPOSE OR OF ANY OTHER KIND, EXPRESSED OR IMPLIED, IS HEREBY MADE.

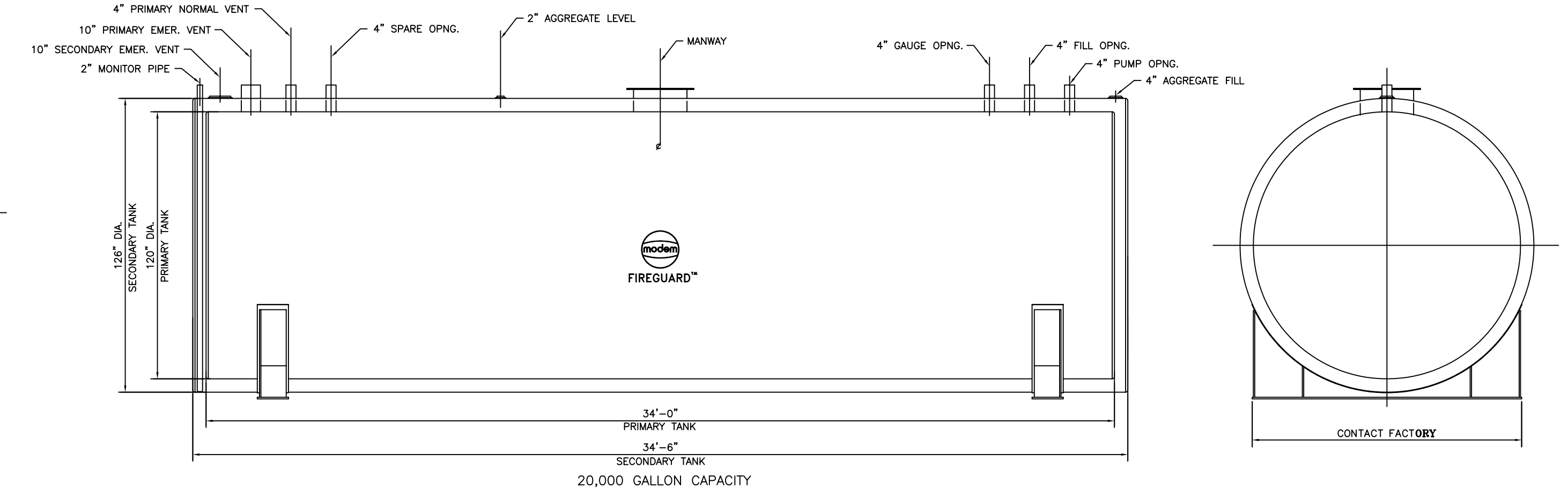
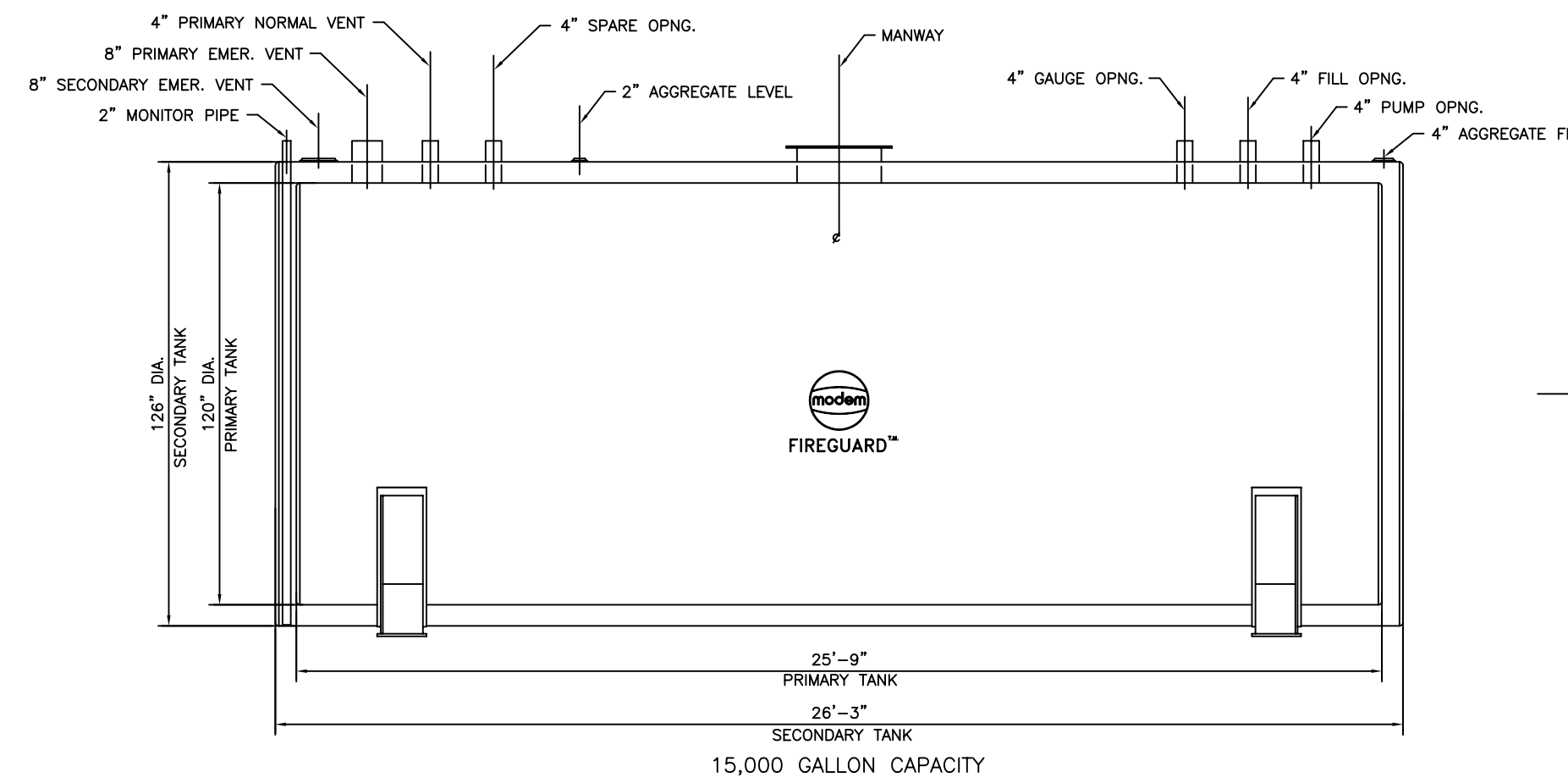
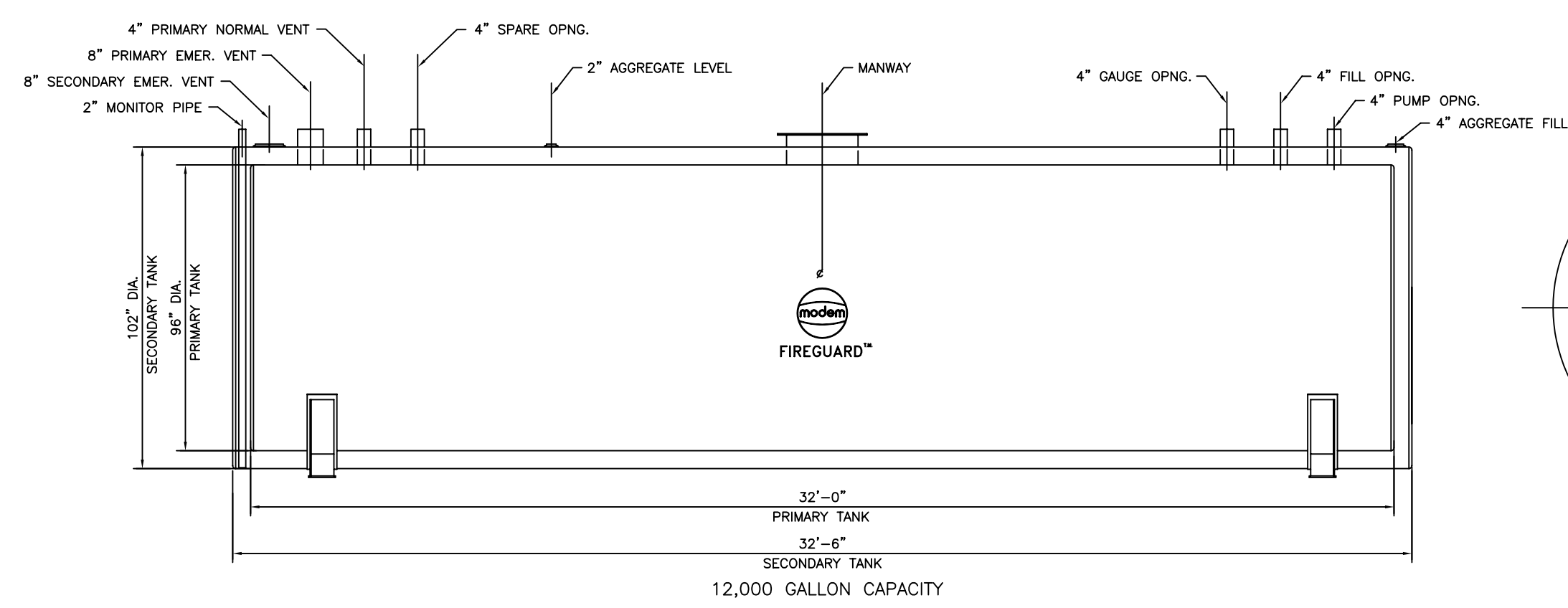
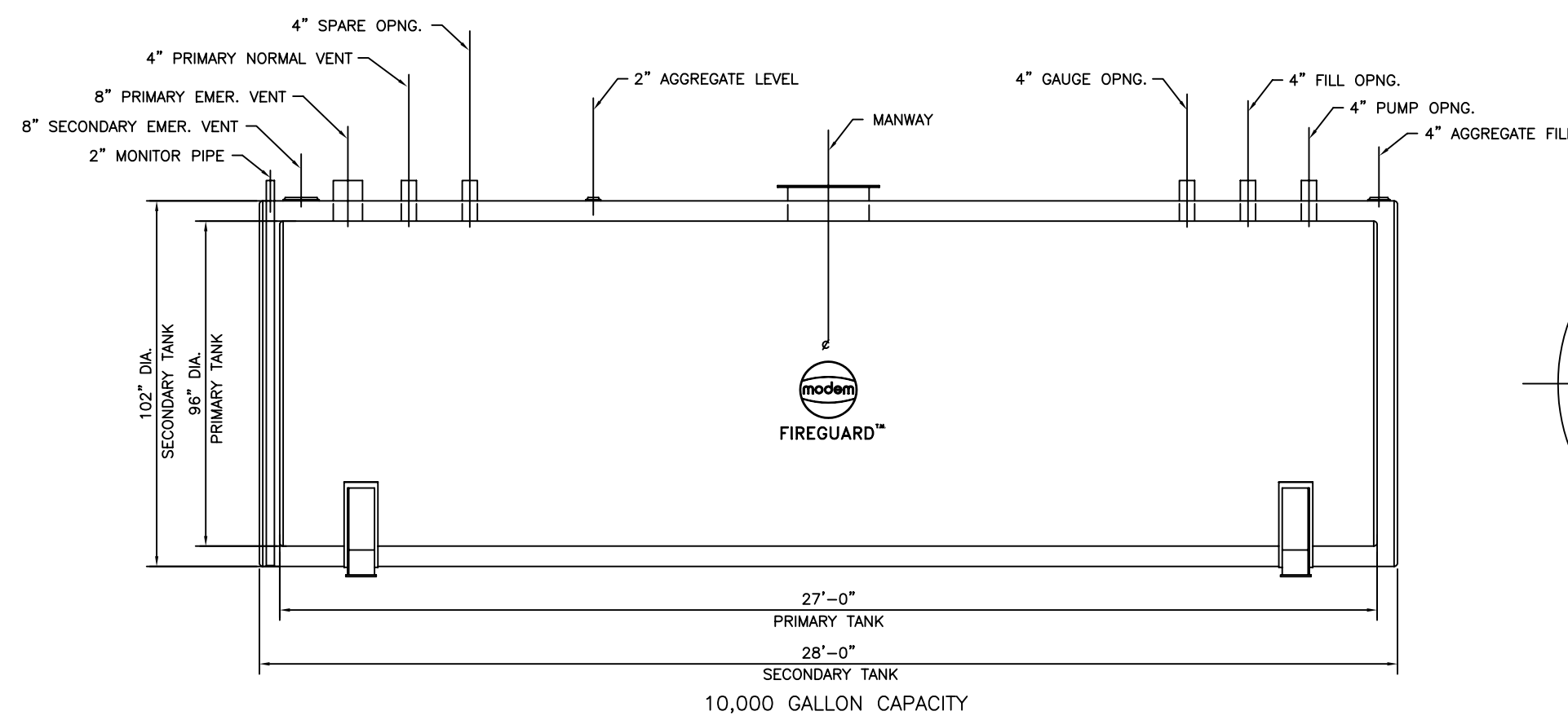
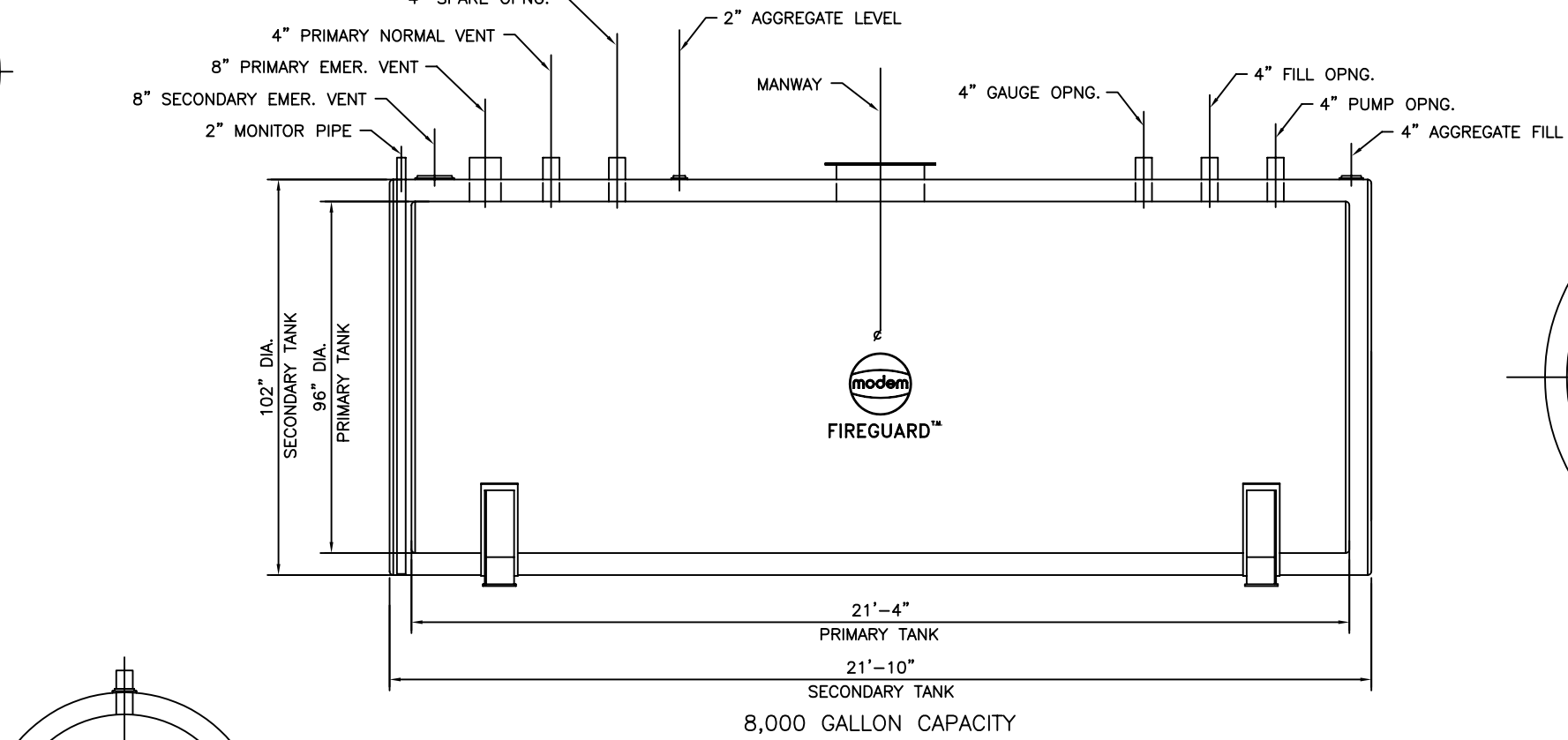
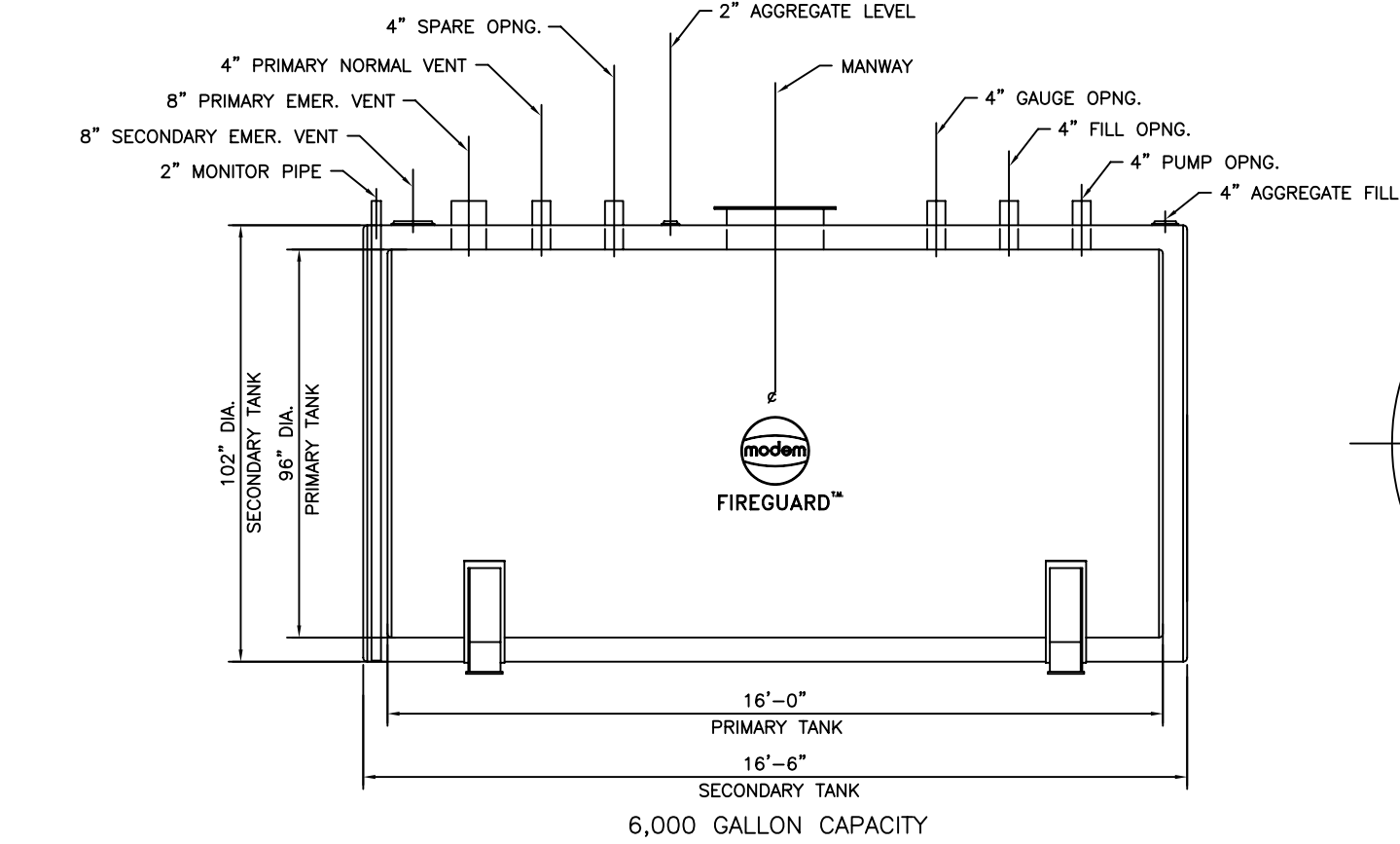
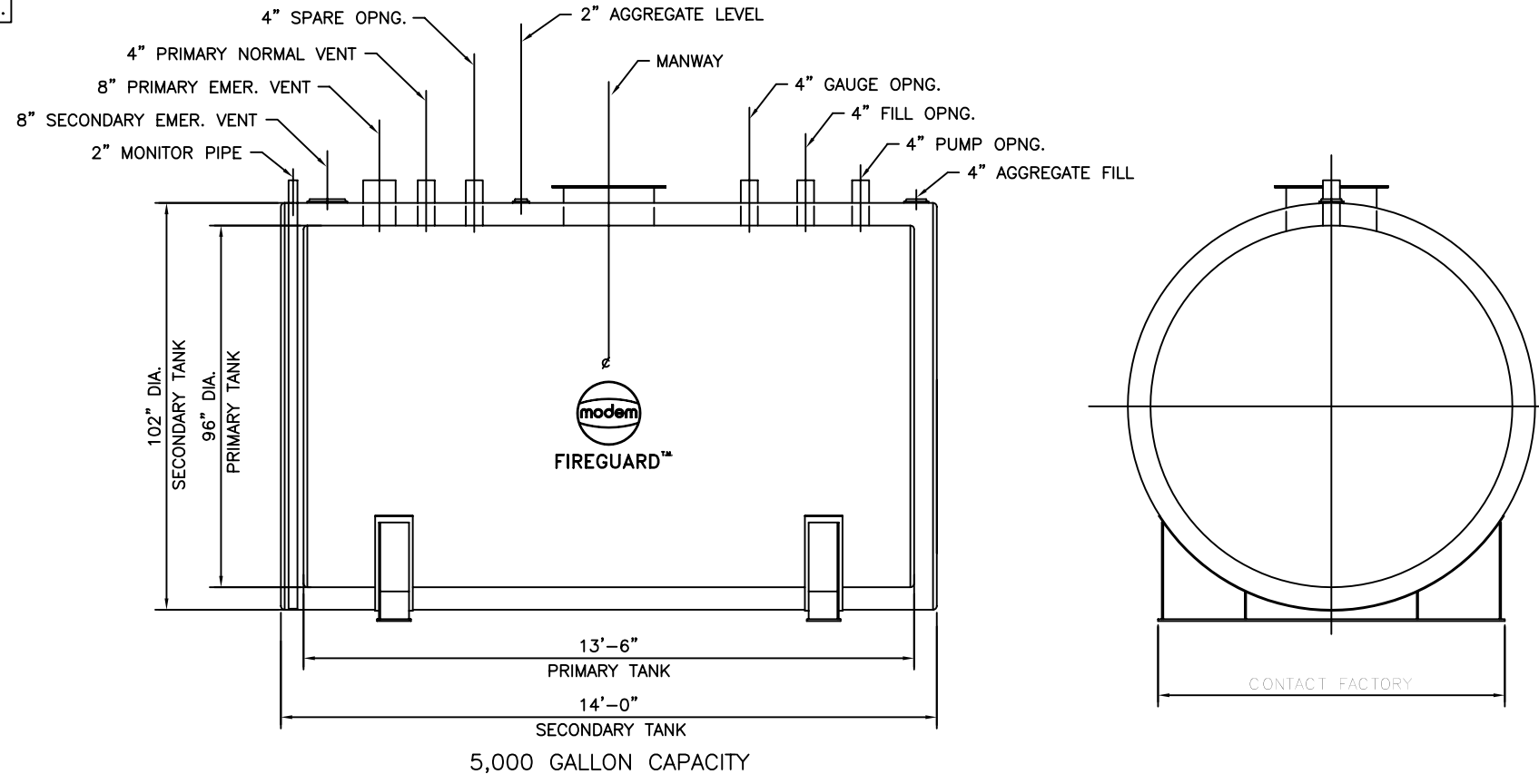
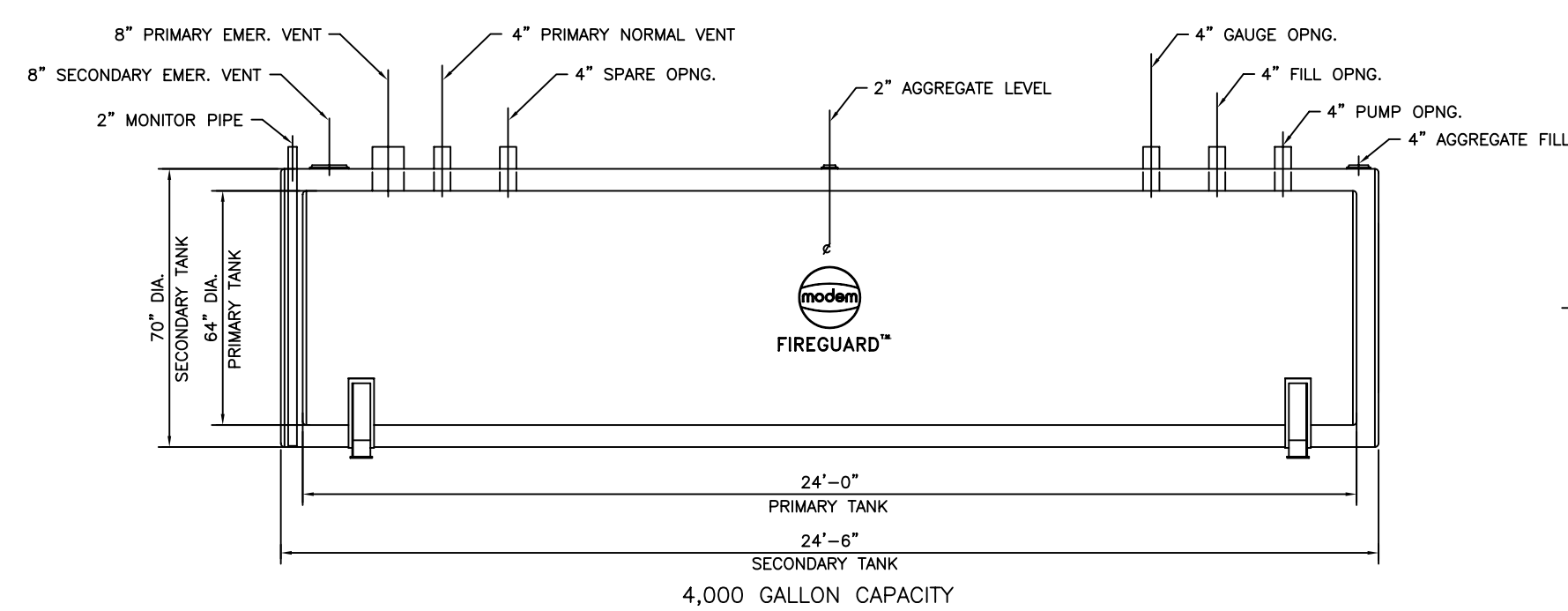
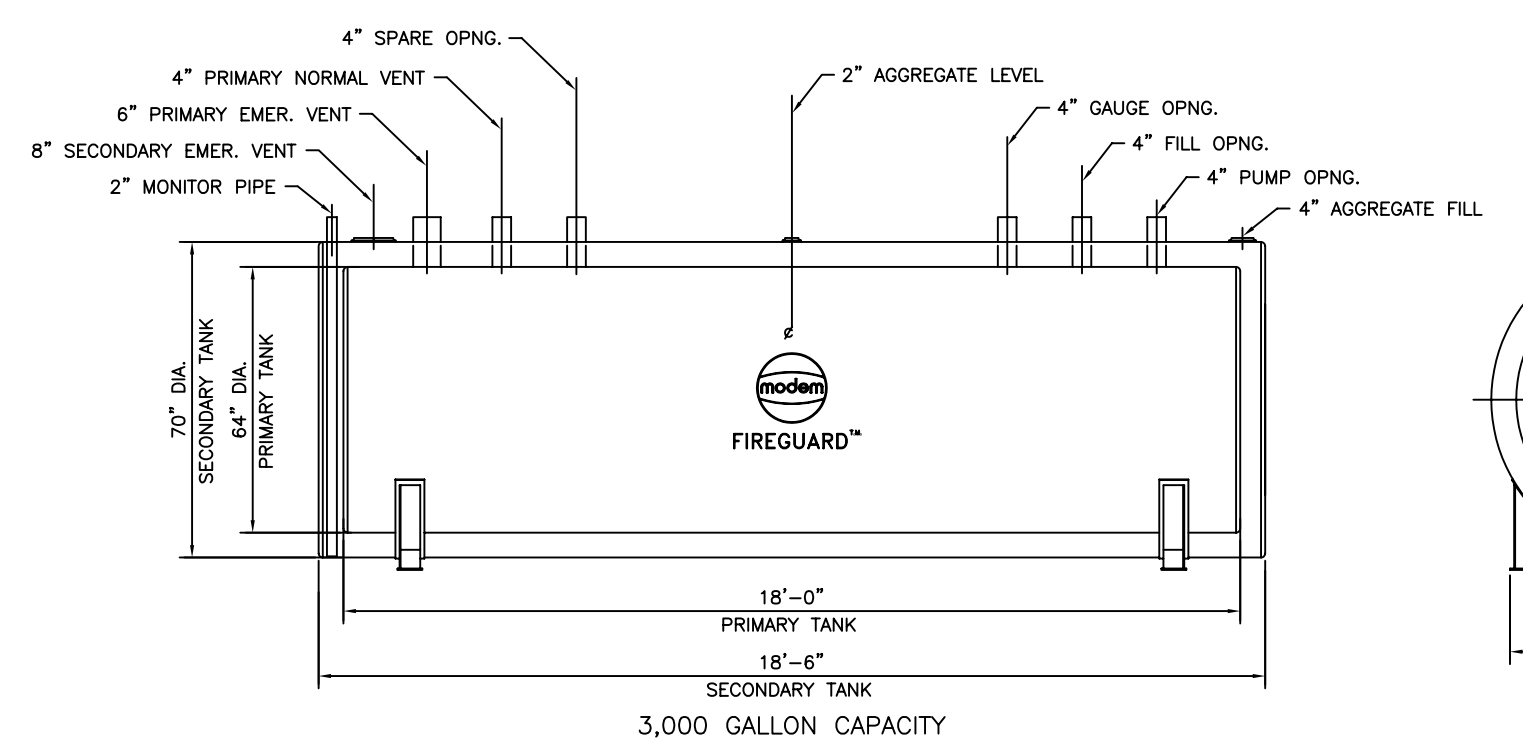
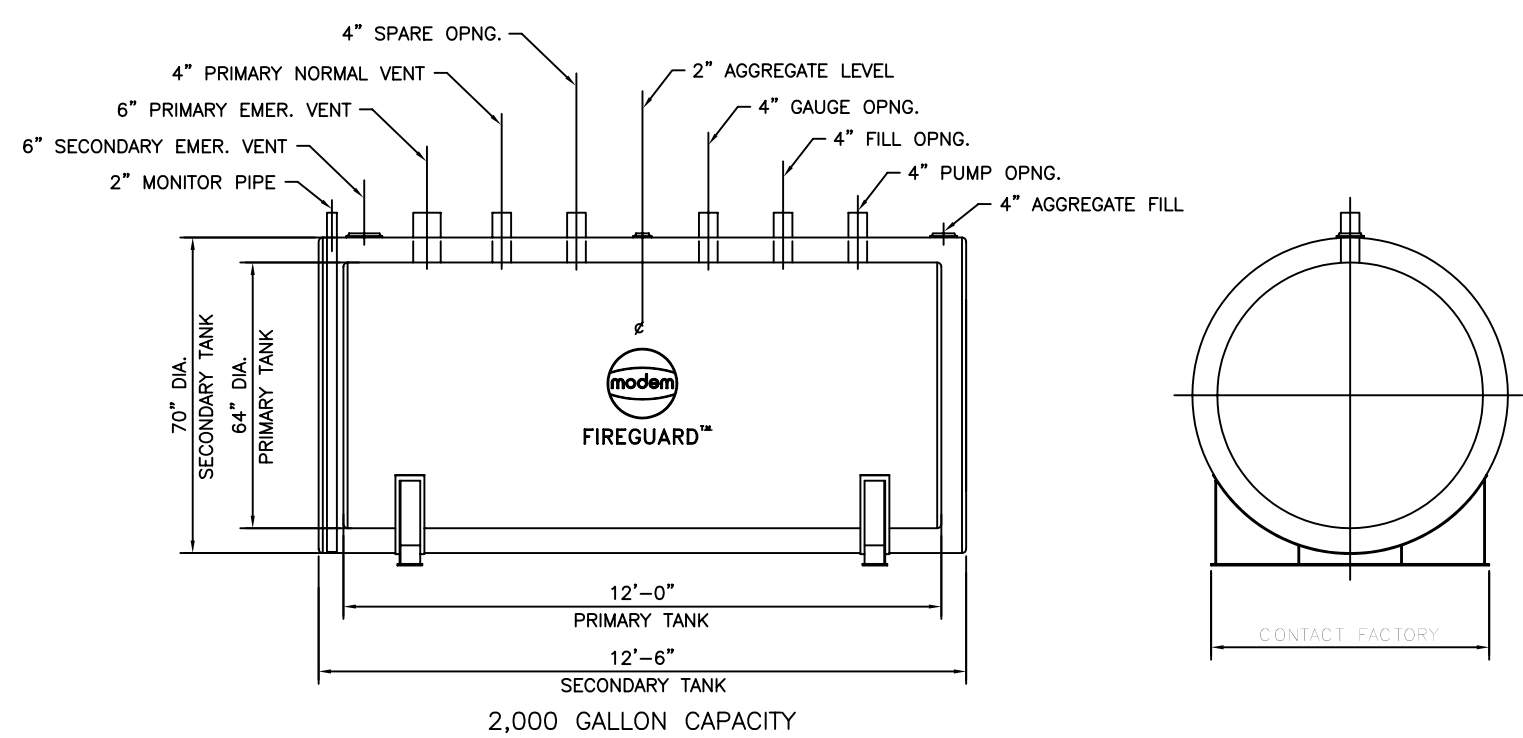
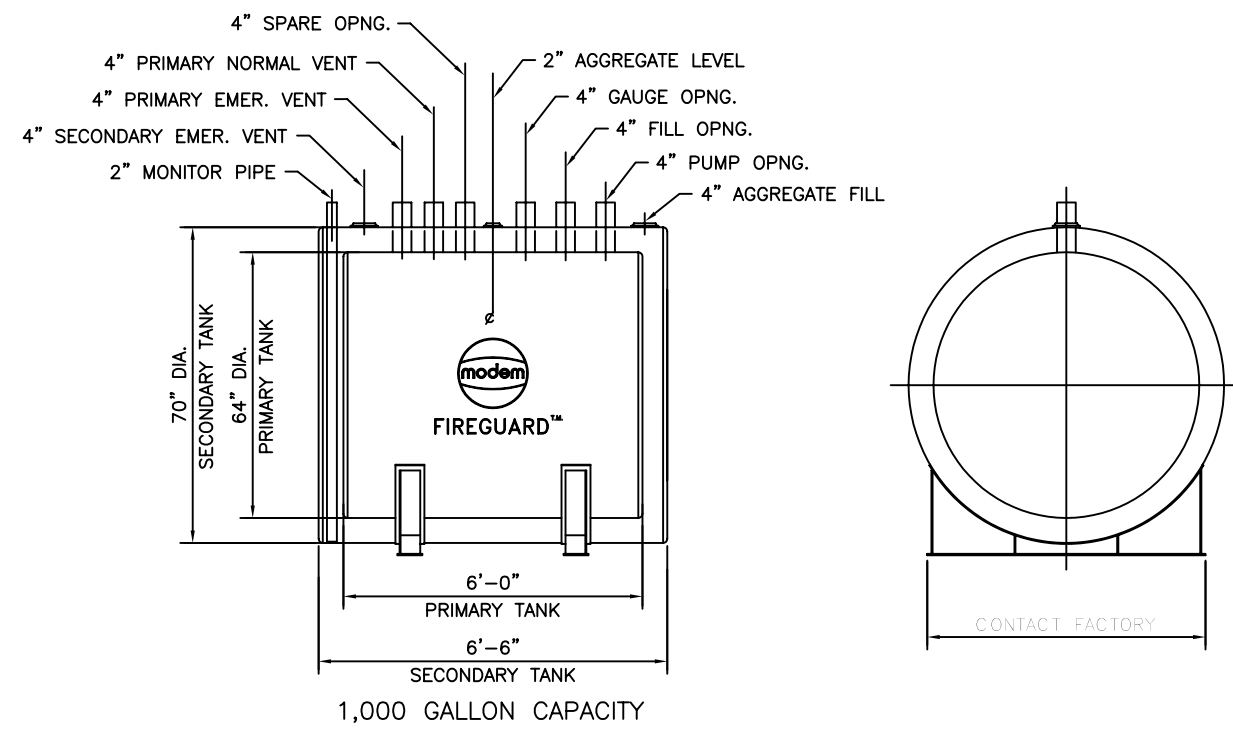
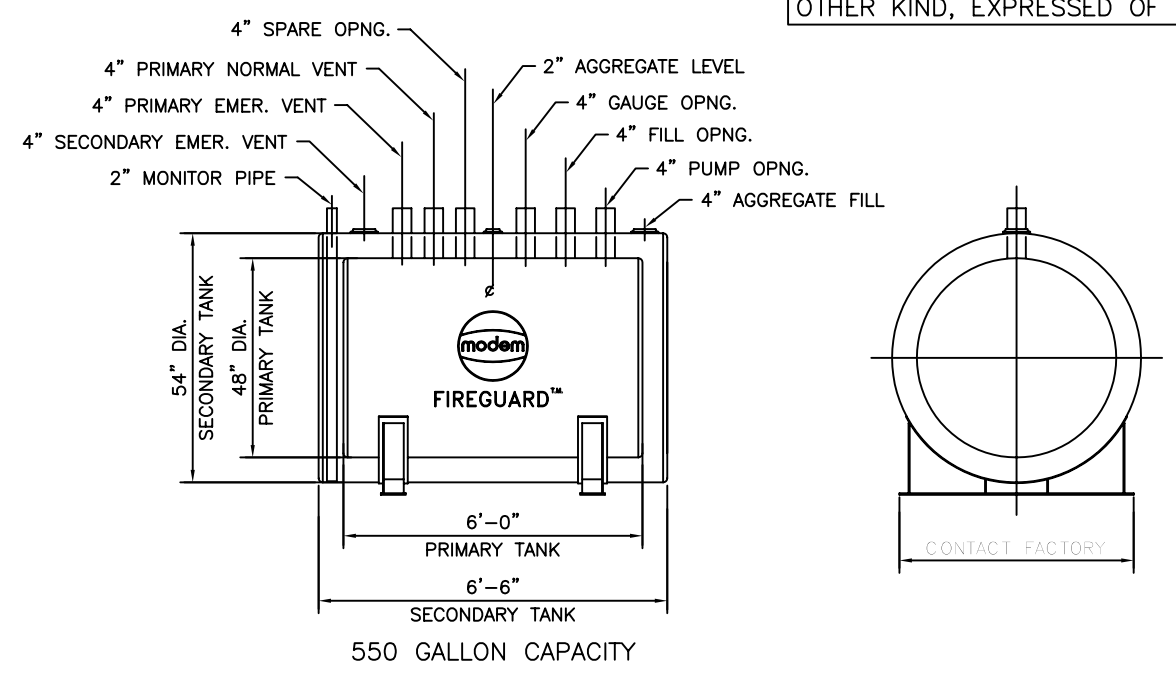

THIS DRAWING IS FOR ILLUSTRATION PURPOSES ONLY AND IS NOT TO BE RELIED UPON FOR ANY OTHER PURPOSE. NO WARRANTY OF MERCHANTABILITY, OF FITNESS FOR A PARTICULAR PURPOSE OR OF ANY OTHER KIND, EXPRESSED OR IMPLIED, IS HEREBY MADE.

FILE: FGCYL

NO. REQ'D		ITEM NO.	
modern welding company, inc.			
2880 New Hartford Road Owensboro, KY. 42302		Corporate Office (270) 685-4400	
"FIREGUARD" INSULATED SECONDARY CONTAINMENT ABOVEGROUND STORAGE TANK			
DWN. BY	DATE	SCALE:	
CHK. BY	JOB NO.	DWG. NO.	▲
APR. BY	P.O. NO.	SHT. NO.	OF